

Ersatzteile für SBF, SBF-plus, NCBF und ASL Spare parts for SBF, SBF-plus, NCBF and ASL

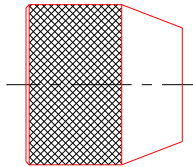

Spannbackensatz/Set of jaws

Artikel-Nr./ref.no.	Spannbereich/range		SBF, SBF-plus, NCBF	SBFD, SBFD-plus, NCBFD	ASL
	mm	inch			
106 0015 000 0	0,2 - 1,5	0 - 1/16	x		
106 1015 000 0	1,5 - 3	1/16 - 1/8	x		
106 0030 000 0	0,2 - 3	0 - 1/8	x		
1D6 0030 000 0	0,2 - 3	0 - 1/8		x	
106 0050 000 0	0,5 - 5	0 - 3/16	x		
106 0065 000 0	0,5 - 6,5	0 - 1/4	x		
1D6 0065 000 0	0,5 - 6,5	0 - 1/4		x	
106 0080 000 0	0,5 - 8	0 - 5/16	x		
106 0100 000 0	0,5 - 10	0 - 3/8	x		
106 0130 000 0	1 - 13	1/32 - 1/2	x		x
1D6 0130 000 0	1 - 13	1/32 - 1/2		x	
106 0160 000 0	1,5 - 16	1/16 - 5/8			x
106 0160 000 0	3 - 16	1/8 - 5/8	x		
1D6 0160 000 0	3 - 16	1/8 - 5/8	x	x	



Verschluss/Hood

Artikel-Nr./ref.no.	Spannbereich/range		SBF, SBF-plus, NCBF	SBFD, SBFD-plus, NCBFD	ASL
	mm	inch			
107 0015 000 0	0,2 - 1,5	0 - 1/16	x		
107 0015 000 0	1,5 - 3	1/16 - 1/8	x		
107 0030 000 0	0,5 - 3	0 - 1/8	x		
1D7 0030 000 0	0,2 - 3	0 - 1/8		x	
107 0050 000 0	0,5 - 5	0 - 3/16	x		
107 0065 000 0	0,5 - 6,5	0 - 1/4	x		
1D7 0065 000 0	0,5 - 6,5	0 - 1/4		x	
107 0080 000 0	0,5 - 8	0 - 5/16	x		
107 0100 000 0	0,5 - 10	0 - 3/8	x		
107 0130 000 0	1 - 13	1/32 - 1/2	x		x
1D7 0130 000 0	1 - 13	1/32 - 1/2		x	
107 0160 000 0	1,5 - 16	1/16 - 5/8			x
107 0160 000 0	3 - 16	1/8 - 5/8	x		

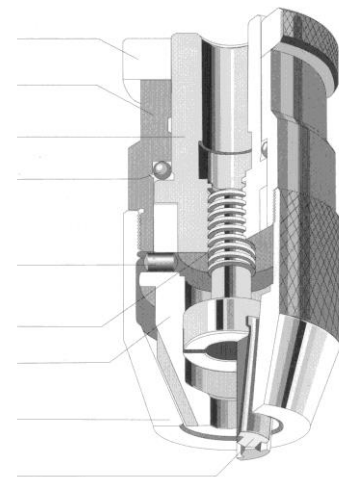
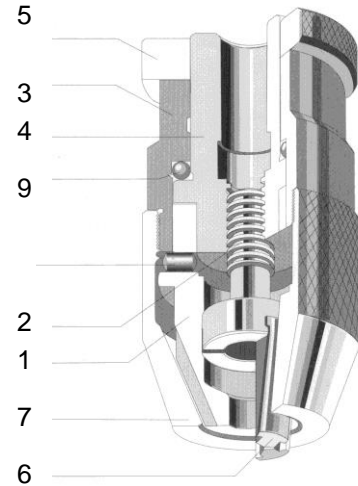

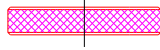

Haltering/collar grip

Artikel-Nr./ref.no.	Spannbereich/range			SBF	SBFD	SBF-plus, SBFD-plus [°]	NCBF, NCBFD [°]
	mm	inch					
105 0015 000 0	0,2 - 1,5	0 - 1/16		x			
105 1015 000 0	1,5 - 3	1/16 - 1/8		x			
105 0030 000 0	0,2 - 3	0 - 1/8		x			
105 0030 WB0 0	0,2 - 3	0 - 1/8			x		
105 0050 000 0	0,5 - 5	0 - 3/16		x			
105 0065 000 0	0,5 - 6,5	0 - 1/4		x			
105 0065 WB0 0	0,5 - 6,5	0 - 1/4			x		
105 0080 000 0	0,5 - 8	0 - 5/16		x			
105 0100 000 0	0,5 - 10	0 - 3/8		x			
125 0100 000 0	0,5 - 10	0 - 3/8					x
105 0130 000 0	1 - 13	1/32 - 1/2		x			
105 0130 WB0 0	1 - 13	1/32 - 1/2			x		
105 013P000 0	1 - 13	1/32 - 1/2				x	
105 013P0B0 0	1 - 13	1/32 - 1/2				x	
125 0130 000 0	1 - 13	1/32 - 1/2					x
125 0130 0B0 0	1 - 13	1/32 - 1/2					x
105 0160 000 0	3 - 16	1/8 - 5/8		x			
105 016P000 0	3 - 16	1/8 - 5/8				x	
125 0160 000 0	3 - 16	1/8 - 5/8					x

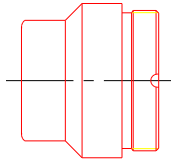

Hülse/Shell

Artikel-Nr./ref.no.	Spannbereich/range			SBF(D)	SBF(D)+plus	NCBF(D)	ASL
	mm	inch					
103 0015 000 0	0,2 - 1,5	0 - 1/16		x			
103 1015 000 0	1,5 - 3	1/16 - 1/8		x			
103 0030 000 0	0,2 - 3	0 - 1/8		x			
103 0050 000 0	0,5 - 5	0 - 3/16		x			
103 0065 000 0	0,5 - 6,5	0 - 1/4		x			
103 0080 000 0	0,5 - 8	0 - 5/16		x			
103 0100 000 0	0,5 - 10	0 - 3/8		x			
123 0100 000 0	0,5 - 10	0 - 3/8				x	
103 0130 000 0	1 - 13	1/32 - 1/2		x			
103 013P 000 0	1 - 13	1/32 - 1/2			x		
123 0130 000 0	1 - 13	1/32 - 1/2				x	
143 0130 000 0	1 - 13	1/32 - 1/2					x
143 0160 000 0	1,5 - 16	1/16 - 5/8					x
103 0160 000 0	3 - 16	1/8 - 5/8		x			
103 016P 000 0	3 - 16	1/8 - 5/8			x		
123 0160 000 0	3 - 16	1/8 - 5/8				x	

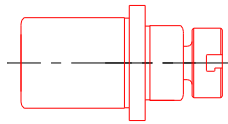

Körper mit Druckspindel (Baugruppe)

Body with Spindle (assembled unit)

Artikel-Nr./ref.no.	Spannbereich/range		Aufnahme/taper	SBF, SBFD	SBF-plus, SBFD-plus	NCBF, NCBFD	ASL
	mm	inch					
124 0015 B06 0	0,2 - 1,5	0 - 1/16	B6 / J0	X			
124 0015 B06 0	1,5 - 3	1/16 - 1/8	B6 / J0	X			
124 0030 B06 0	0,2 - 3	0 - 1/8	B6 / J0	X			
124 0030 B10 0	0,2 - 3	0 - 1/8	B10	X			
124 0030 J 01 0	0,2 - 3	0 - 1/8	J1	X			
124 0030 G01 0	0,2 - 3	0 - 1/8	5/16" - 24	X			
124 0050 B10 0	0,5 - 5	0 - 3/16	B10	X			
124 0050 B12 0	0,5 - 5	0 - 3/16	B12	X			
124 0050 J 01 0	0,5 - 5	0 - 3/16	J1	X			
124 0050 G01 0	0,5 - 5	0 - 3/16	5/16" - 24	X			
124 0065 B10 0	0,5 - 6,5	0 - 1/4	B10	X			
124 0065 B12 0	0,5 - 6,5	0 - 1/4	B12	X			
124 0065 J 01 0	0,5 - 6,5	0 - 1/4	J1	X			
124 0065 G01 0	0,5 - 6,5	0 - 1/4	5/16" - 24	X			
124 0065 G02 0	0,5 - 6,5	0 - 1/4	3/8" - 24	X			
124 0065 G03 0	0,5 - 6,5	0 - 1/4	1/2" - 20	X			
124 0080 B10 0	0,5 - 8	0 - 5/16	B10	X			
124 0080 B12 0	0,5 - 8	0 - 5/16	B12	X			
124 0080 J 02 0	0,5 - 8	0 - 5/16	J2	X			
124 0080 G02 0	0,5 - 8	0 - 5/16	3/8" - 24	X			
124 0080 G03 0	0,5 - 8	0 - 5/16	1/2" - 20	X			
124 0100 B12 0	0,5 - 10	0 - 3/8	B12	X			
124 0100 B16 0	0,5 - 10	0 - 3/8	B16	X		X	
124 0100 J 02 0	0,5 - 10	0 - 3/8	J2	X		X	
124 0100 J 33 0	0,5 - 10	0 - 3/8	J33	X			
124 0100 G03 0	0,5 - 10	0 - 3/8	1/2" - 20	X			
124 0100 G04 0	0,5 - 10	0 - 3/8	5/8" - 16	X			
124 0130 B12 0	1 - 13	1/32 - 1/2	B12	X			
124 0130 B16 0	1 - 13	1/32 - 1/2	B16	X		X	
124 0130 J 02 0	1 - 13	1/32 - 1/2	J2	X		X	
124 0130 J 33 0	1 - 13	1/32 - 1/2	J33	X		X	
124 0130 J 06 0	1 - 13	1/32 - 1/2	J6	X		X	
124 0130 G03 0	1 - 13	1/32 - 1/2	1/2" - 20	X			
124 0130 G04 0	1 - 13	1/32 - 1/2	5/8" - 16	X			
124 0130 G05 0	1 - 13	1/32 - 1/2	3/4" - 16	X			
124 0130 MK2 0	1 - 13	1/32 - 1/2	MK 2		X		
124 0130 MK3 0	1 - 13	1/32 - 1/2	MK 3		X		
124 0130 MK4 0	1 - 13	1/32 - 1/2	MK 4		X		
124 0130 R08 0	1 - 13	1/32 - 1/2	R 8		X		
124 0130 Z16 0	1 - 13	1/32 - 1/2	ø 16		X		
124 0130 Z58 0	1 - 13	1/32 - 1/2	ø 5/8"		X		
124 0130 Z32 0	1 - 13	1/32 - 1/2	ø 32		X		
124 0130 Z140	1 - 13	1/32 - 1/2	ø 1 1/4"		X		
124 0130 000 0	1 - 13	1/32 - 1/2	ASL				X
124 0160 000 0	1,5 - 16	1/16 - 5/8	ASL				X
124 0160 B16 0	3 - 16	1/8 - 5/8	B16	X		X	
124 0160 B18 0	3 - 16	1/8 - 5/8	B18	X		X	
124 0160 J 06 0	3 - 16	1/8 - 5/8	J6	X		X	
124 0160 MK2 0	3 - 16	1/8 - 5/8	MK 2		X		
124 0160 MK3 0	3 - 16	1/8 - 5/8	MK 3		X		
124 0160 MK4 0	3 - 16	1/8 - 5/8	MK 4		X		
124 0160 R08 0	3 - 16	1/8 - 5/8	R 8		X		

Aus funktions-technischen Gründen können Körper und Druckspindel nicht einzeln, sondern nur als Baugruppe geliefert werden.

Due to operational reasons body and spindle can only be delivered as a unit and not separately.

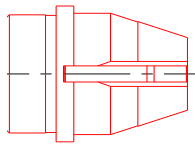

Backenträger / Jaw guide

Artikel-Nr./ref.no.	Spannbereich/range			SBF(D), NCBF(D)	SBF(D)-plus	ASL
	mm	inch				
101 0015 000 0	0,2 - 1,5	0 - $\frac{1}{16}$		X		
101 0015 000 0	1,5 - 3	$\frac{1}{16}$ - $\frac{1}{8}$		X		
101 0030 000 0	0,2 - 3	0 - $\frac{1}{8}$		X		
101 0050 000 0	0,5 - 5	0 - $\frac{3}{16}$		X		
101 0065 000 0	0 - 6,5	0 - $\frac{1}{4}$		X		
101 0080 000 0	0,5 - 8	0 - $\frac{5}{16}$		X		
101 0100 000 0	0,5 - 10	0 - $\frac{3}{8}$		X		
101 0130 000 0	1 - 13	$\frac{1}{32}$ - $\frac{1}{2}$		X	X	X
101 0160 000 0	1,5 - 16	$\frac{1}{16}$ - $\frac{5}{8}$				X
101 0160 000 0	3 - 16	$\frac{1}{8}$ - $\frac{5}{8}$		X		

Schlüssel für ASL Wrench for ASL

Artikel-Nr./ref.no.				
149 0000 900 0	2-kt.-Gabelschlüssel / wrench			X

Kugelsatz Set of Balls

Artikel-Nr./ref.no.	Spannbereich / range					
	mm	inch				
109 0015 100 0	0,2 - 1,5	0 - $\frac{1}{16}$		X		
109 0015 100 0	1,5 - 3	$\frac{1}{16}$ - $\frac{1}{8}$		X		
109 0030 100 0	0,2 - 3	0 - $\frac{1}{8}$		X		
109 0050 100 0	0,5 - 5	0 - $\frac{3}{16}$		X		
109 0065 100 0	0,5 - 6,5	0 - $\frac{1}{4}$		X		
109 0080 100 0	0,5 - 8	0 - $\frac{5}{16}$		X		
109 0100 100 0	0,5 - 10	0 - $\frac{3}{8}$		X		
109 0130 100 0	1 - 13	$\frac{1}{32}$ - $\frac{1}{2}$		X		X
109 0050 142 0	1 - 13	$\frac{1}{32}$ - $\frac{1}{2}$			X	
109 0130 100 0	1,5 - 16	$\frac{1}{16}$ - $\frac{5}{8}$				X
109 0160 100 0	3 - 16	$\frac{1}{8}$ - $\frac{5}{8}$		X		
109 0160 125 0	3 - 16	$\frac{1}{8}$ - $\frac{5}{8}$			X	

Schlingfeder Spring clutch

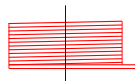

Artikel-Nr./ref.no.	Spannbereich/range		
	mm	inch	
120 0100 001 0	0,5 - 10	0 - $\frac{3}{8}$	X
120 0130 001 0	1 - 13	$\frac{1}{32}$ - $\frac{1}{2}$	X
120 0160 001 0	3 - 16	$\frac{1}{8}$ - $\frac{5}{8}$	X

Stelling Set collar



Artikel-Nr./ref.no.	Spannbereich/range		
	mm	inch	
128 0100 000 0	0,5 - 10	0 - $\frac{3}{8}$	X
128 0130 000 0	1 - 13	$\frac{1}{32}$ - $\frac{1}{2}$	X
128 0160 000 0	3 - 16	$\frac{1}{8}$ - $\frac{5}{8}$	X